

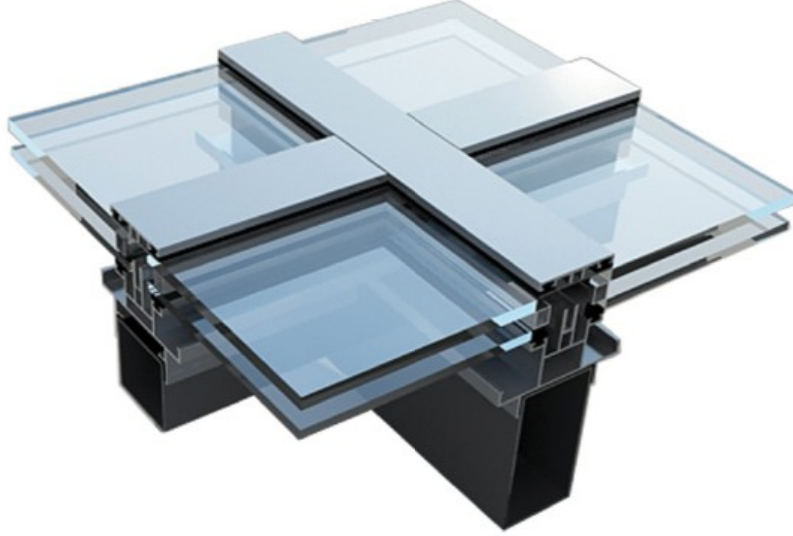

## SİSTEMLER KATOLOĞU

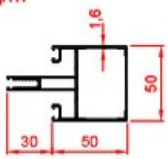
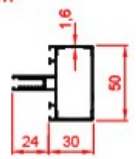
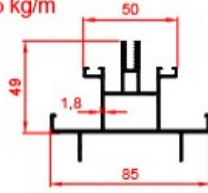
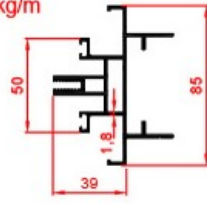
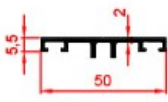
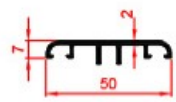
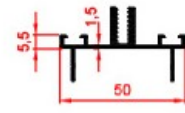
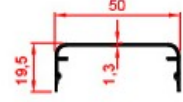
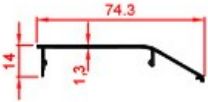
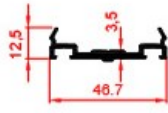

İŞIKLIK SİSTEMİ

<p>5008 1.596 kg/m</p> 	<p>5013 1.149 kg/m</p> 	<p>5108 1.585 kg/m</p> 	<p>5109 1.653 kg/m</p> 
<p>5110 0.390 kg/m</p> 	<p>5111 0.429 kg/m</p> 	<p>5112 0.617 kg/m</p> 	<p>5046 0.334 kg/m</p> 
<p>5047 0.369 kg/m</p> 	<p>5048 0.467 kg/m</p> 	<p>5058 0.244 kg/m</p> 