

Aksesuar Ürün Katalođu

**AKPA**<sup>®</sup>

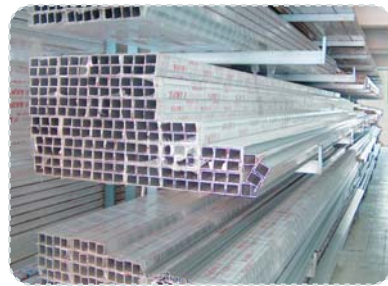

### BUTİLLİ ALM. PROFİL



Butillli Alm. Profil	Metre / Karton L=6
6 mm	1500
9 mm	1000
10.5 mm	1000
12 mm	1000
14.5 mm	500
15.5 mm	500

### HOLT-MELT CAM YAPIŞTIRICISI



Stok Kodu  
10 020200

### ISICAM KLİPSİ



Isıcam Klipsi
6 mm
9 mm
10.5 mm
12 mm
14.5 mm
15.5 mm

### BUTİL CAM YAPIŞTIRICI



Stok Kodu  
10 020300

### NEM ALICI



Stok Kodu  
10 030100

### EKOPLAST ÇİFT CAM MACUNU

EKOPLAST A 30 KG  
EKOPLAST B 3 KG



Stok Kodu  
10 020150 (A)  
10 020151 (B)

### THOMSİT R 710 BUCKET 5+1 KG



Stok Kodu  
08 020103

### COSMOFEN 819 ALÜMİNYUM KÖŞE YAPIŞTIRICI



Stok Kodu  
08 010102

### FANTASEAL 0,5MM\*1500MM\* 37,5 MT



Stok Kodu  
08 100301

### OL-FOİLBAND 1,0\*50 MM\*10MT



Stok Kodu  
08 100201



08 060103

Poliüretan Köpük

750 ml



08 060104

Tabanlı Köpük

750 ml



08 060201

Selfix Sprey

Tab. Temizleyici



Anti Bakteriyel Silikon

310 ml

Şeffaf-Beyaz-Kahve  
Siyah-Krem-Gri



605 B Nötür Silikon

Şeffaf-Beyaz-Siyah-Gri



08 010202

YAPIŞTIRICI HARÇ  
EPEKSİ



08 110200

Color Spray 400 ml.



08 050130

SOUDAL FIXAL KUVVETLİ  
YAPIŞTIRICI



Derz Dolgu Fitali

6 mm-10 mm-15 mm  
20 mm-25 mm-30 mm



İZOMASTİK KARTUS

Gri-Beyaz-Kahve-A.Meşe



08 050102

İzo Pvc Slikonize Mastik



08 010203

MERMER  
YAPIŞTIRICISI



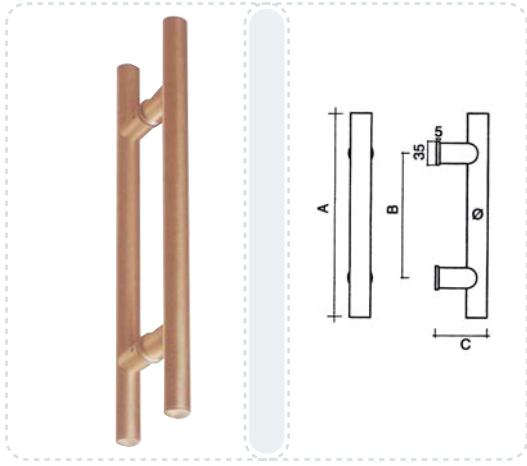

### H - KOL

		A	B	C
H30S060	30	600	400	75
H30S090	30	900	700	75
H30S120	30	1200	900	75
H30S150	30	1500	1200	75

'A' ve 'B' istenen ölçülerde üretilebilir.  
'A' ve 'B' can be produced in desired dimensions.

### YAY KOL

		A	B	C	D
H30S050	30	500	420	85	85
H30S080	30	800	720	100	100

'A' ve 'B' istenen ölçülerde üretilebilir.  
'A' ve 'B' can be produced in desired dimensions.

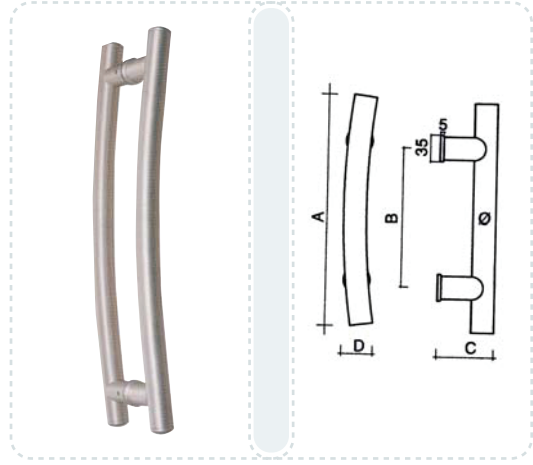

KD070/40-100 KALE H KOL PASLANMAZ

KD070/40-102 KALE H KOL PASLANMAZ

KD070/40-103 KALE H KOL PASLANMAZ

KD070/40-104 KALE H KOL PASLANMAZ

KD070/40-105 KALE H KOL PASLANMAZ

KD070/40-106 KALE H KOL PASLANMAZ

LAMA BANT KOL | 90 cm - 100 cm | Beyaz - Renkli - Elokıallı

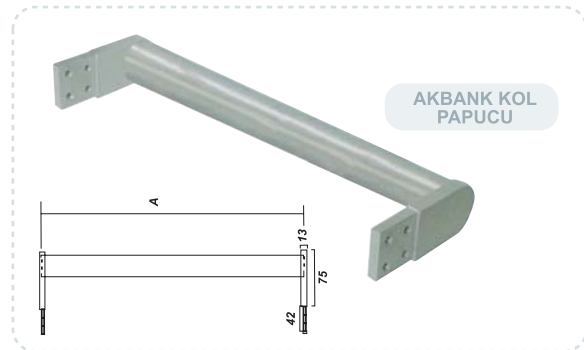



	Ø mm
K20A010	20 97
K20A015	20 150
K25A020	25 200
K25A030	25 300
K25A040	25 350
K25A010	25 400
K30A010	30 350
K25A020	30 600



AK 2025 Kapı Kolu  
Beyaz  
Eloksallı



	Ø mm
U20A010	20 97
U20A015	20 150
U25A020	25 200
U25A030	25 300
U25A035	25 350
U25A040	25 400
U30A035	30 350
U30A060	30 600



	Ø mm
V25A020	25 200
V25A025	25 250
V25A030	25 300
V25A035	25 350
V25A035	30 350



	Ø mm
Y20A010	20 97
Y20A015	20 150
Y25A020	25 200
Y25A030	25 300
Y30A030	30 300
Y30A035	30 350



	Ø mm
L25A090	25 900
L25A100	25 1000
L30A090	30 900
L30A100	30 1000
L30A125	30 1250



Yarım Ay Kapı Kolu  
Beyaz  
Renkli  
Eloksallı



Yan Çekme Kol  
20 mm -15 mm  
Beyaz  
Renkli  
Eloksallı



01 020102

İSP. KOL BEYAZ

BOYALI



01 020302

YENİ İSP.

KOL B. BOY.



01 020201

OVAL İSPANYOLET KD

ELOKSALLI



01 020550

GİZLİ CEPHE KANAT KOLU

NATUREL BOYALI



01 100400

DIŞ CEPHE KOLU



01 040902

YAYLI KİLİTLİ KOL

METAL FORZA BEYAZ

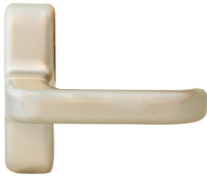

01 021203

EURO EKSENEL TEK  
DİLLİ RENKLİ



01 100402

EURO GIESSE

CEPHE KOLU BEYAZ



01 020601

R29W ROTOLINE

EKSENEL KOL



01 071012

İZO SÜRME KOL



01 020702

ÇİFT DİLLİ EKSENEL

PENCERE KOLU BEYAZ



01 020402

POLİTEKNİK KOL  
BEYAZ



01 020604

ROTOLİNE ALM. KİLİTLİ  
KOL NATUREL



20 000035

ROTOLİNE SECUSTİK  
PENCERE KOLU



01 071013

PLASTİK SÜRME  
KİLİT KOLU



01 070900

SÜRME KİLİT BEYAZ

01 040502

VİDASIZ YAYLI SOSİS  
KOL BEYAZ



01 032002

C KOL BEYAZ



01 031802

D ÇEKME KOL BEYAZ



01 031702

10 CM KARE KOL  
B.BOYALI

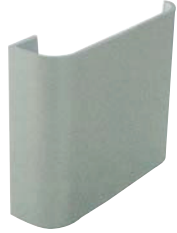

01 040702

ALPİNA SOSİS KOL  
BEYAZ



01 040102

ROZETLİ SOSİS KOLU  
BEYAZ



01 050302

YAYLI TETİK KOL BEYAZ



01 040104

YAYLI SOSİS KOL



01 050305

KİLİTLİ TETİK KOL  
ELOKSALLI



01 041002

PX 811 YENİ YAYLI KOL  
B.B. FORZA

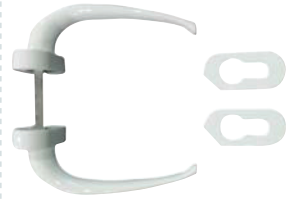

01 050702

BRIO HAVUZ KİLİT



05 011500  
DSL 7910 SÜRME KOL  
BEYAZ

05 011501  
DSL 7910 SÜRME KOL  
SİYAH

05 011502  
DSL 7910 SÜRME KOL  
GRİ



01 050402

TUBA ÇEKME HAVUZ  
KOL BEYAZ



01 040308

BÜTÜN AYNALI KOL



05 011510

DS7910 SÜRME  
KOL KİTİ





01 010802

C 60 YAPRAK  
MENTEŞE BEYAZ



01 011002

İZO ÜÇGEN PİVOT  
MENTEŞE BEYAZ



01 010302

GEÇME MENTEŞE  
BEYAZ



01 011602

Y.S 3 LÜ MENTEŞE  
BEYAZ



01 011810

FLASH XL EURO  
GROOVE MENTEŞE



01 011102

İZO GENCER MENTEŞE  
BEYAZ



01 011302

Y.S 2 Lİ MENTEŞE  
BEYAZ



01 010602

ALDOKS MENTEŞE  
BEYAZ

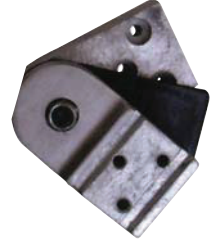

01 010402

BİNME MENTEŞE  
B. BOYALI



01 012101

YAYLI MENTEŞE NO:33  
KADYUMLU



01 012206

YAYLI MENTEŞE ALM  
NO:33 SATEN



01 010501

BABA MENTEŞE



01 010902

İZO MENTEŞE BEYAZ

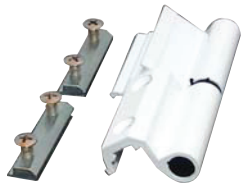

01 010202

DÜZ ALDOKS  
MENTEŞE BEYAZ

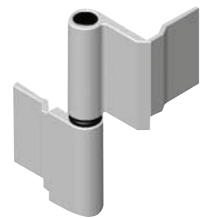

01 010904

BURSA MENTEŞE



01 010702

C 60 MENTEŞE  
BEYAZ



01 080102

13 CM VASİSTAS  
MAKASI B.BOYALI



01 081703

ALM. AYARLI İZO  
ÇARPMA



01 081000

AYARLI VASİSTAS  
MAKASI (3 KADEME)



01 080201

22 CM VASİSTAS  
MAKASI ELOKSALLI



01 081000

AYARLI VASİSTAS  
MAKASI



01 080800

ALM.OVAL SERİ  
VASİSTAS MAKASI



01 100304

Cephe Makası (GSHD16)  
1200 - 1400

01 100305

Cephe Makası (GSHD18)  
1400 - 1400

01 100306

Cephe Makası (GSHD20)  
1600 - 1500



01 081502

VASİSTAS ÇARPMA  
BEYAZ B.



01 060102

KİLİT KARŞILIĞI BEYAZ  
BOYALI DİLLİ



01 060102

KİLİT KARŞILIĞI BEYAZ  
BOYALI MAKARALI

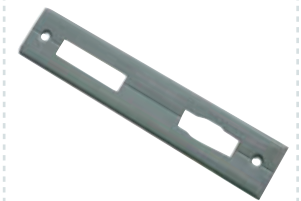

01 060302

İZO KİLİT KARŞILIĞI  
BEYAZ DİLLİ



01 060302

İZO KİLİT KARŞILIĞI  
BEYAZ MAKARALI



01 060210

OVAL SERİ KİLİT  
KARŞILIĞI



01 060202

C 60 KİLİT KARŞILIĞI  
BEYAZ



01 070502

SAVYO SÜRGÜ  
B.BOYALI



01 070202

UZUN ZAMAK  
SÜRGÜ BEYAZ



01 070402

FİŞEK SÜRGÜ  
BEYAZ BOYALI

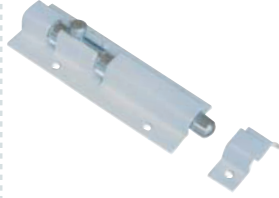

01 070302

GÖMME SÜRGÜ  
B.BOYALI

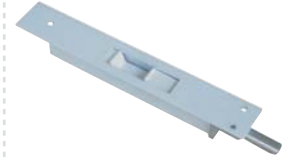

01 070602

C 60 ÇİFT PİMLİ  
SÜRGÜ BEYAZ



01 070102

UFAK ZAMAK  
SÜRGÜ BEYAZ



01 071100

Y.S FİŞEK SÜRGÜ



01 081400

VASİSTAS MAKASI  
ÇELİK

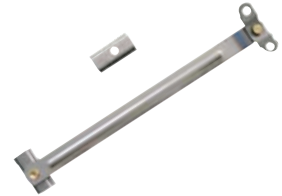

01 080500

13 CM İZO SAC  
VASİSTAS MAKASI



01 070154

EURO ZAMAK SÜRGÜ  
KISA RENKLİ BOYALI





01 130210

ARAKAYIT BAĞLANTISI  
GENİŞ



01 130201

ALDOKS KÖŞE  
BAĞLANTISI YAYSIZ



KELEBEK AYARLI  
İSPANYOLET KARŞILIĞI



01 130207

ARAKAYIT  
BAĞLANTISI DAR



01 120200

AYARLI İSPANYOLET  
KARŞILIĞI



01 130305

Y.S ALYAN BAĞLANTI



01 130212

C 60 ARAKAYIT  
BAĞLANTI SAÇ



01 120101  
İSPANYOLET PİMİ KISA



01 120100  
İSPANYOLET PİMİ  
UZUN



MO.44.İSİ YALITIM  
KANAT BAĞLANTI

MO.44.GENİŞ  
YALITIMSIZ  
KAN.BAĞLANTI



01 130322

L ORTAKAYIT  
BAĞLANTISI



01 130306

MO.41 YS.ALYAN  
KÖŞE 19 MM 0423



01 130308

MS.04 24MM 0404  
SÜRME BAĞLANTI

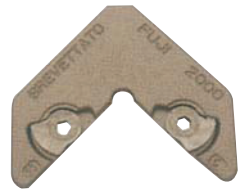

01 130314  
FUJİ 2000



01 130313

M0 42.00490  
ZAMAK DAR BAĞ.



01 130318

MO 19 İNCE  
L KÖŞE



01 130307

MS.04 Y.S ALYAN  
KÖŞE 26 MM 0365



01 130316

MO 20 PLS KÖŞE





01 150200

ALÜMİNYUM KAPI  
ALTI FIRÇASI



01 150201

ALÜMİNYUM YAN  
KAPI ALTI FIRÇASI



01 150100

KAPI ALTI FIRÇASI  
AHŞAP



CEPHE TAKVİYE  
TAKOZLARI



01 100500

PLS YAKA



01 071015

İZO SÜRME  
DOĞRAMA SETİ



01 100100

100 LUK  
F ANKRAJ



01 100116

100 LUK  
U ANKRAJ



01 100111

100 LUK  
L ANKRAJ



01 110301

SKS 99 C SÜRME  
KAPI SİSTEMİ



01 100501

KIRLANGIÇ  
GEÇME YAKASI

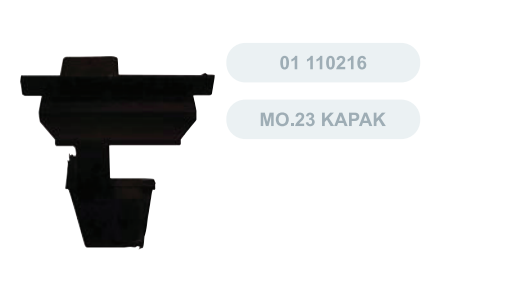

01 110216

MO.23 KAPAK



01 110226

MO.97 KAPAK



01 110221

MO.37 KAPAK



01 120600

PLS KİT-AL  
AKSESUAR



01 120300

KÖRSOMUNLU  
SAPLAMA



01 100200

M 10 BAĞLANTI  
CİVATA GRUBU

01 100204

M 10\*85 ÇELİK DÜBEL



Stok Kodu	Ürün Adı	Birim
04 060080	Fiberglass Tül 80 x 30	m <sup>2</sup>
04 060100	Fiberglass Tül 100 x 30	m <sup>2</sup>
04 060120	Fiberglass Tül 120 x 30	m <sup>2</sup>
04 060140	Fiberglass Tül 140 x 30	m <sup>2</sup>
04 060160	Fiberglass Tül 160 x 30	m <sup>2</sup>

Açıklama	Rulo Metre	Koli Metre
Pb 48 x 45 Kıl Fitol	550 mt	2200 mt
Pb 48 x 80 Kıl Fitol	350 mt	1400 mt
Pb 68 x 60 Kıl Fitol	350 mt	1400 mt
Pb 68 x 70 Kıl Fitol	300 mt	1200 mt
Pb 68 x 80 Kıl Fitol	250 mt	1000 mt
Pb 68 x 100 Kıl Fitol	200 mt	800 mt
Pb 68 x 120 Kıl Fitol	200 mt	800 mt
Pb 68 x 150 Kıl Fitol	125 mt	500 mt
Pb 68 x 180 Kıl Fitol	125 mt	500 mt

09 050103

OTOMATİK  
MAKARA  
FLASH



09 010102

PANJUR  
MAKARASI  
BEYAZ



09 100105

PLASTİK PANJUR  
KASNAĞI



09 040103

PLASTİK PANJUR  
BORU BAŞI

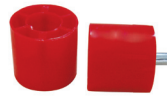

09 070102

16 MM PANJUR  
KORDONU



01 110100

RULMAN  
PLASTİK TEKLİ

01 110128

CAM CAMA  
RULMAN



01 110139

MS 0102 TEKLİ  
MAKARA AYARLI

01 110112

TUBA MAKARA  
ÇİFTLİ SARI



01 110134

MS 0201 ÇİFTLİ  
MAKARA AYARLI

01 110107

TUBA MAKARA  
SARI



ALÜM. ÇİFTLİ  
RULMAN AYARLI

01 110117

TUBA MAKARA  
PLASTİK



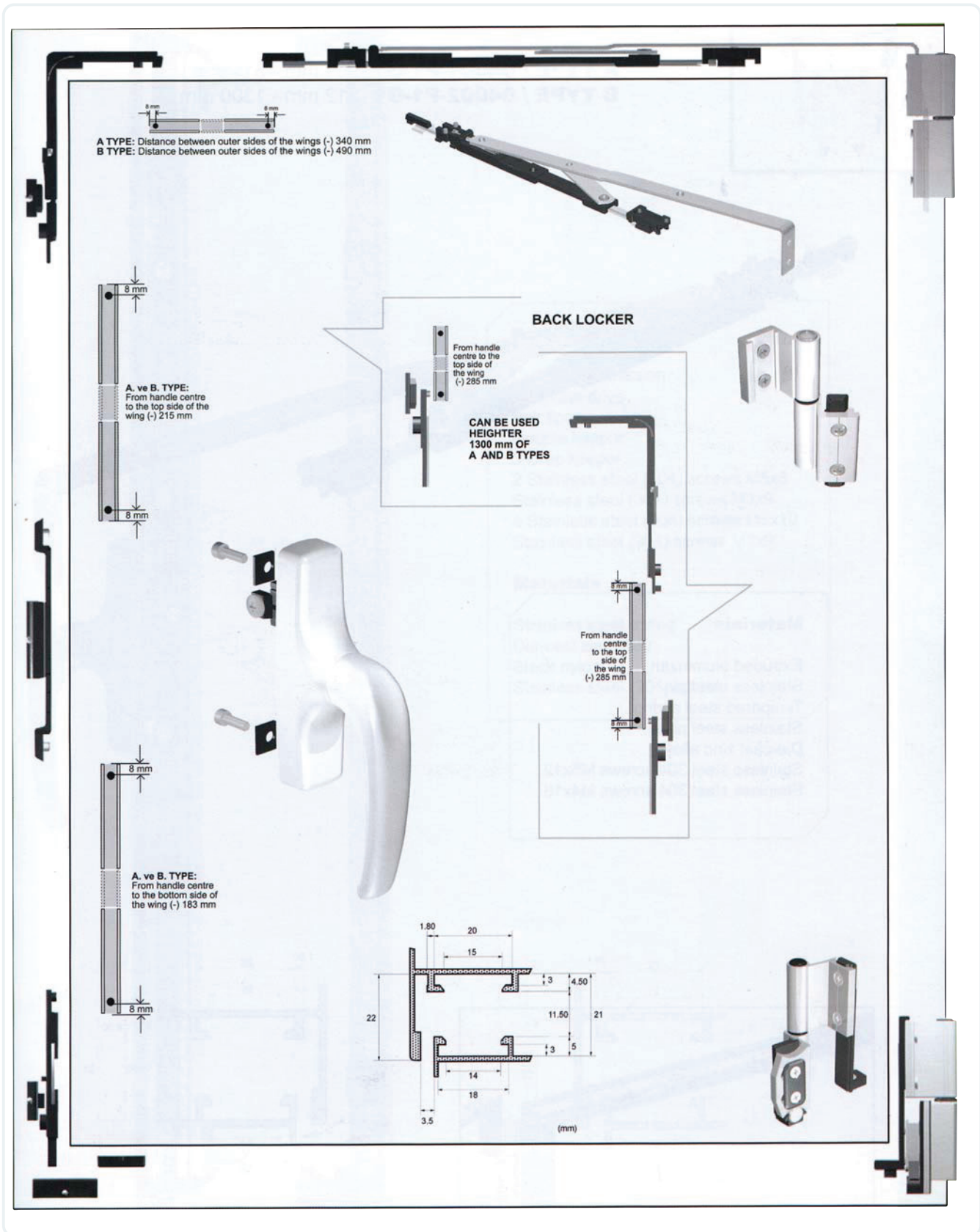

- 01 090502 FR ALÜMİNYUM ÇİFT AÇILIM TİP 1 BEYAZ
- 01 090602 FR ALÜMİNYUM ÇİFT AÇILIM TİP 2 BEYAZ

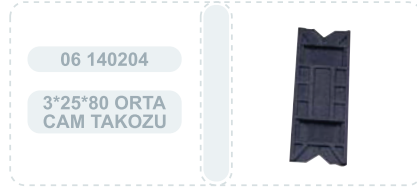



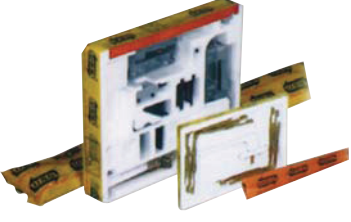

06 160502

USS LUX SÜRME  
2000 MM BEYAZ

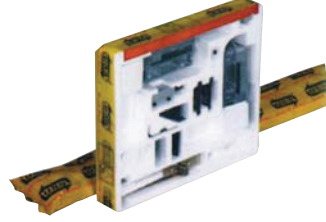

06 160302

USS KLS. SÜRME  
2000 MM BEYAZ



06 140300

TİP 01-18 MM  
AYARLI C.T.



06 140301

TİP 02-24 MM  
AYARLI C.T.



06 140306

TİP 07-32 MM  
AYARLI C.T.

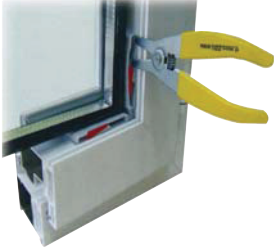

06 140299

AYAR  
PENSESİ



06 160102  
ESS SÜRME 2000 MM BEYAZ



USS Klasik Alüminyum profiller için



01 140126

AK-903 ÜÇAYAK KÖŞE.



01 140101  
CAM BİNECEĞİ METAL

01 140106  
CAM BİNECEĞİ PLASTİK



01 140114  
SİGMA BAĞLANTI



01 140110  
CAM KİLİDİ



04 105013  
SİNEKLİK TUTMA KOLU D-KOL



04 044005  
4005 - 2 Eko SineklikRulmanı



KÖŞE BİRLEŞTİRME TAKOZU



04 100100  
SİNEKLİK MIKNATISLI ÇİT ÇİT



SİNEKLİK KÖŞE TAKOZU



06 150102  
HAVUZ KOL PLS.BEYAZ



04 022020  
17\*25 SİNEKLİK  
KÖŞE TAKOZU 45



SİNEKLİK  
TUTMA KOLU  
(KÜÇÜK)



SİNEKLİK  
TUTMA KOLU  
(BÜYÜK)



04 022019  
10\*20 SİNEKLİK  
KÖŞE TAKOZU 45



04 022007  
10\*20 SİNEKLİK  
BAĞ. PAPUCU



04 022010  
TUTMA KOLU  
BÜYÜK



04 022009  
17\*25 SİNEKLİK  
BÜYÜK MENT.  
(DEM. PİML.)



SİNEKLİK  
KÖŞE TAKOZU  
PENCERE İÇİN 90°



04 022031  
17\*25 SİNEKLİK  
BÜYÜK MENT.(PLS.PİML)



04 022008  
17\*25 SİNEKLİK  
KÖŞE TAKOZU 90



04 022005  
SİNEKLİK TUTMA  
HALKASI



04 022012  
17\*25 SİNEKLİK  
BAĞLAMA PAPUCU



04 022011  
17\*25 SİNEKLİK  
BÜYÜK ÇİTÇİT



04 022003  
TUTMA KOLU  
PLS KÜÇÜK



SİNEKLİK TUTAMAK  
BÜYÜK



04 022001  
10\*20 SİNEKLİK  
KÖŞE TAKOZU 90°



SİNEKLİK TUTMA  
HALK. ALTI



SİNEKLİK MENTEŞE  
PENCERE KAPI İÇİN  
( PLS PİMLİ )



04 022004  
10\*20 SİNEKLİK  
KÜÇÜK ÇİTÇİT



SİNEKLİK MENTEŞE  
PENCERE İÇİN  
(DEMİR PİMLİ)

### 100 cm PVC GÖBEKLİ İSPANYOLET



06 010100	30 cm	SAC GÖBEK DÜZ İSPANYOLET
06 010101	40 cm	SAC GÖBEK DÜZ İSPANYOLET
06 010102	60 cm	SAC GÖBEK DÜZ İSPANYOLET
06 010103	80 cm	SAC GÖBEK DÜZ İSPANYOLET
06 010104	100 cm	SAC GÖBEK DÜZ İSPANYOLET
06 010105	120 cm	SAC GÖBEK DÜZ İSPANYOLET
06 010106	140 cm	SAC GÖBEK DÜZ İSPANYOLET
06 010107	160 cm	SAC GÖBEK DÜZ İSPANYOLET
06 010108	180 cm	SAC GÖBEK DÜZ İSPANYOLET
06 010109	200 cm	SAC GÖBEK DÜZ İSPANYOLET

### 100 cm PVC Düz İSPANYOLET



06 010200	30 cm	PVC DÜZ İSPANYOLET
06 010201	40 cm	PVC DÜZ İSPANYOLET
06 010202	60 cm	PVC DÜZ İSPANYOLET
06 010203	80 cm	PVC DÜZ İSPANYOLET
06 010204	100 cm	PVC DÜZ İSPANYOLET
06 010205	120 cm	PVC DÜZ İSPANYOLET
06 010206	140 cm	PVC DÜZ İSPANYOLET
06 010207	160 cm	PVC DÜZ İSPANYOLET
06 010208	180 cm	PVC DÜZ İSPANYOLET
06 010209	200 cm	PVC DÜZ İSPANYOLET

### Kilitli Kapı İspanyoleti 92 EKS



### Kilitli Kapı İspanyoleti 85 EKS



### 06 140400 PVC Güvenlik Emniyet Mandalı



### 06 140402 Elit Emniyet Mandalı



### 06 140406 MKS GÜVENLİK KİLİDİ



### 06 140900 TEFLON YAPIŞKANLI



06 060102

Pls Pencere Kolu

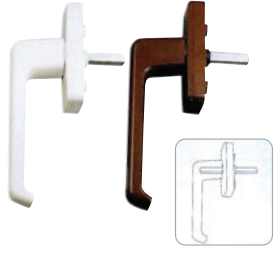

06 060102

Pls Pencere Kolu 'Güneş'



06 060202

Pls Pencere Kolu 'Bulut' Demirli



06 060202

Pls Pencere Kolu 'Yıldız' Demirli



06 060602

Alüminyum Lüks Pınar Kol



06 060610

Alüminyum Lüks Pınar Kol R. Boyalı



06 070702

Mesut Alüminyum Wc Kapı Kolu Dar



06 070902

ALM. KİLİTLİ İSP KOLU 92 EKS.



06 070802

Pınar Alüminyum Kilitli Kapı Kolu 85 Eksen



06 070602

Pınar Alüminyum Wc Kapı Kolu



06 070814

Mesut Alüminyum Kilitli Kapı Kolu Geniş Yaylı 85 Eksen



06 070818

Mesut Alüminyum Kilitli Kapı Kolu 85 Eksen



06 060402

ALM. KİLİTLİ  
PENCERE KOLU



06 070710

ALM. MESUT WC  
KAPI KOLU  
RENKLİ BOYALI



06 021302

FORZA AYARLI  
KAPI MENTEŞESİ  
BEYAZ



06 070102

ALM KİLİTLİ  
KAPI KOLU



06 020302

ZAMAN KAPI  
MENTEŞESİ 90'lık



06 020202

80 MM ZAMAK  
KANAT MENTEŞESİ



06 120102

PLS VASİSTAS  
ÇARPMA BEYAZ

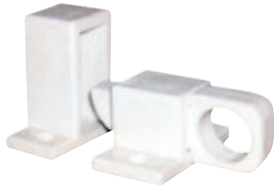

06 020402

ZAMAN KAPI  
MENTEŞESİ 95'lik





06 150102  
HAVUZ KOL PLS.  
06 150302  
GÖMME KÜÇÜK  
TUTAMAK  
06 150402  
GÖMME BÜYÜK  
TUTAMAK



06 120402  
ALM. VASİSTAS  
MAKAS 13 CM  
06 120702  
SAC VASİSTAS  
MAKAS 13 CM



06 150202  
SÜRME GÖMME  
KOL BEYAZ



06 150508

SAÇ SÜRME  
TEKER ÇİFTLİ  
AYARLI PLS



06 140704

KİLİT KARŞILIĞI  
SAC



06 150500

SÜRME RULMAN  
PLS. KÜÇÜK



06 120502  
ALM.VASİSTAS  
MAKAS 22 CM

06 120802  
SAC VASİSTAS  
MAKAS 22 CM



01 170102

İSPANYOLET  
ÇUBUĞU 75 MM  
BEYAZ



06 140601

AYARLI KİLİT  
KARŞILIĞI  
UNI KISA



06 140703

KİLİTLİ İSP  
KARŞILIĞI ST-2



06 150506

SÜRME  
İSPANYOLET  
KARŞILIĞI



06 120900

BALKON KAPI  
ÇİT ÇİTİ



06 140600

AYARLI KİLİT  
KARŞILIĞI  
UNI UZUN



06 140702

KİLİTLİ İSP  
KARŞILIĞI ST-1



06 140502

SAC KANAT  
SÜRGÜ



06 140503

SAC KAPI  
SÜRGÜ



06 140500

ZAMAK ÇİFT  
KANAT SÜRGÜSÜ



ZAMAK ORTA  
KAYIT



ZAMAK İSP  
KARŞILIK



06 150501

SÜRME RULMAN  
PLS. BÜYÜK



05 011001

153/25 U KALE  
S.SİLİNDİRLİ (GÖVDE)  
25 MM



05 010202

154/ KALE SÜPER  
S MAKARALI (KİLİT)  
35 MM

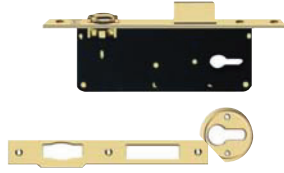

05 010900

301/B KALE PVC  
ALM SÜRME KİLİT

05 010904

302/B KALE PVC  
ALM.SÜRME KİLİT



05 010114

201/F KALE  
SİLİNDİRLİ SÜRME  
KİLİDİ 20MM



05 010311

269/PWC-35 KALE  
PVC BANYO 35 MM



05 011113

164/GMC KALE SÜP.  
CER.MAND. BAR.  
68 MM WC



05 011118

164/BNE KALE  
BİLYALI BAREL 68 MM



05 010205

155B KALE  
MAKARALI ÇARPMA  
35 MM



05 010403

155/25 KALE ALM.  
SİLİNDİRLİ (GÖVDE)  
25 MM



05 010100

152/R KALE SÜPER  
SİLİNDİRLİ (KİLİT)  
35 MM

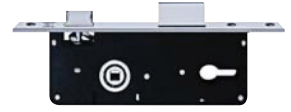

05 011131

164/GN 81 KALE  
SÜP.CERMAN BAREL  
81 MM



05 010408

269/WC 35 KALE ALM.  
BANYO WC 35 MM

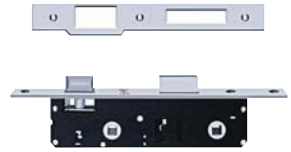

05 011400

ELEKTRİKLİ KAPI  
KARŞILIĞI KALE 222

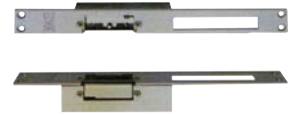

05 010415

TOROS 35x85  
ALÜMİNYUM KİLDİ



05 011102

164/GNC KALE SÜP.  
CER. BAR. 68 MM



05 010609

357/MS KALE EL.KAPI  
OTO.KIL MAK. PAS.



11 030901

KAPI EMNİYET  
APARAT TAKIMI



05 021203

90 mm  
NORMAN BAREL



11 030421

KD070/20-114  
KALE ÜST T  
MENTEŞE



11 030414

KD070/20-123  
KALE CAM KİLİDİ



05 021207

83 mm  
NORMAN BAREL



01 160108

KD040/35-320  
KALE TOPUZLU  
KİLİT



11 030419

KD/70 20-125  
KALE CAM KAPI  
EMNİYET KİLİDİ



## SAÇ VİDALARI



		BOY													
Ç A P	2,9 mm	6,5	9,5	13	16	19	22								
	3,5 mm	6,5	9,5	13	16	19	22	25	32						
	3,9 mm	6,5	9,5	13	16	19	22	25	32	38					
	4,2 mm		9,5	13	16	19	22	25	32	38	45	50	60	70	80
	4,8 mm		9,5	13	16	19	22	25	32	38	45	50			
	5,5 mm			13	16	19	22	25	32	38	45	50			
	6,3 mm				16	19	22	25	32	38	45	50			

## MATKAP UÇLU VİDALAR

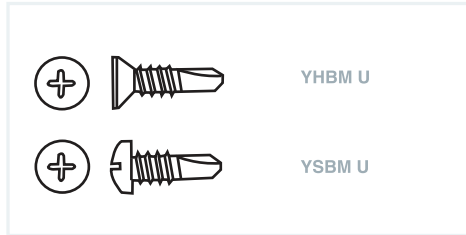

		BOY							
Ç A P	3,9 mm	13	16	19	22	25	32	38	
	4,2 mm		16	19	22	25	32	38	
	4,8 mm		16	19	22	25	32	38	45

## İSPANYOLET VİDALARI

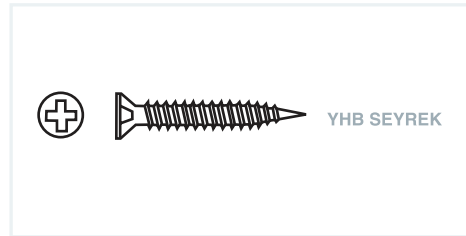

		EBAT	TİP
Ç A P	3,9 X 22	YHB SEYREK	
	3,9 X 22	YHB SEYREK (Hİ-LO)	
	3,9 X 25	YHB SEYREK	
	3,9 x 25	YHB SEYREK (Hİ-LO)	
	3,9 x 32	YHB SEYREK	
	3,9 X 38	YHB SEYREK	
	4,1 X 25	YHB SEYREK (ÖZEL)	
	4,2 X 32	YHB SEYREK	
	4,2 x 38	YHB SEYREK	
	4,2 x 45	YHB SEYREK	

## SUNTA VİDASI



		EBAT	TİP
Ç A P	6*60	SUNTA VİDASI	
	6*70	SUNTA VİDASI	
	6*80	SUNTA VİDASI	
	6*100	SUNTA VİDASI	
	6*120	SUNTA VİDASI	
	6*150	SUNTA VİDASI	

## BETON MONTAJ VİDALARI

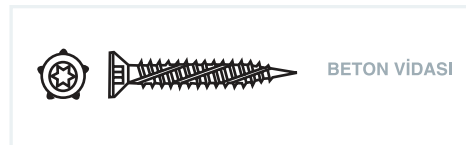

		EBAT	TİP
Ç A P	7,5 x 60	BETON VİDA (Dübelsiz)	
	7,5 x 80	BETON VİDA (Dübelsiz)	
	7,5 x 100	BETON VİDA (Dübelsiz)	
	7,5 x 120	BETON VİDA (Dübelsiz)	
	7,5 x 132	BETON VİDA (Dübelsiz)	
	7,5 x 150	BETON VİDA (Dübelsiz)	

## POP PERÇİN

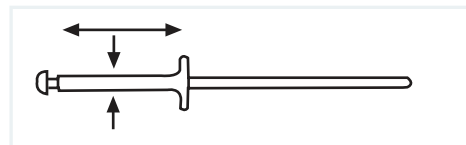

		BOY (L)							
Ç A P	4	8	10	12	15	18	20	25	
	5	8	10	12	15	18	20	25	

## ÇELİK DÜBEL

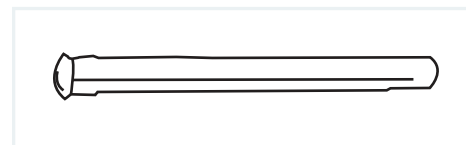

		BOY (L)						
ÇAP	M6	60	80	100	120	132	150	180



		EBAT	TİP
Ç A P	4*8	POP PERÇİN	
	4*10	POP PERÇİN	
	4*12	POP PERÇİN	
	4*15	POP PERÇİN	
	4*18	POP PERÇİN	
	5*10	POP PERÇİN	
	5*12	POP PERÇİN	
	5*18	POP PERÇİN	
	5*20	POP PERÇİN	

KESİT	SİPARİŞ KODU	MAMÜL ADI	METRAJ	KESİT	SİPARİŞ KODU	MAMÜL ADI	METRAJ
	03 020501	HORTUMLU CAM FİTİLİ 6 MM	100		03 020101	ALDOKS AKSAN FİTİL	100
	03 020502	HORTUMLU CAM FİTİLİ 4 MM	100		03 020102	ALDOKS ÇİFT KULAK AKSAN FİTİLİ	100
	03 020503	HORTUMLU CAM FİTİLİ 3 MM	100		03 020103	ALDOKS MAÇALI AKSAN FİTİLİ	100
		AY FİTİLİ 4 MM	150		03 020104	ALDOKS İTALYAN GENİŞ FİTİL	100
		AY FİTİLİ 3 MM	150			ALDOKS FİTİL 7 MM	100
	03 020203	ALDOKS MAÇALI FİTİLİ	100		03 020402	ALDOKS ÇİFT KULAK FİTİLİ	100
	03 020204	ALDOKS İTALYAN FİTİLİ	100		03 020203	ALDOKS MAÇALI FİTİLİ	100
	03 020114	SİNEKLİK FİTİLİ 4 MM	100		03 020206	ALDOKS ÇAKMA MAÇALI FİTİL	100
	03 020115	SİNEKLİK FİTİLİ 5 MM	100		03 020410	OMEGA GENİŞ FİTİL	100
	03 020705	C 60 KANAT FİTİL	100		03 020401	ALDOKS GENİŞ FİTİL	100
		OMEGA ÖZEL FİTİL	200		03 020402	ALDOKS ÇİFT KULAK GENİŞ FİTİL	100
	03 070101	CONTA 2024 ( 4 MM )	250		03 015614	CONTA 5614 ( 3 MM )	260 mt
	03 070106	KAMA FİTİLİ 2026 ( 2 MM )	350		03 070103	KAMA FİTİL 2025 ( 3 MM )	260
		F2 KALIN CONTA	155		03 070105	KAMA FİTİLİ 2261 ( 5 MM )	200
	03 080100	MO 60 PVC OMEGA FİTİL	200		03 080101	MO 68 PVC EPİL 82 FİTİL	150

11 030303-KD002/50-330 KALE KAPI HİDROLİĞİ (GRİ)

11 030305-KD-002/50-400 KALE KAPI HİDROLİĞİ

11 030313-KD-002/40-330 KALE KAPI HİDROLİĞİ P.R.

11 030400-KD-070/10-100 KALE CAM DETAY

11 030401-KD-070/10-200 KALE STANDART DETAY



CAM DETAY AKSESUAR

ALÜMİNYUM DETAY AKSESUAR

STANDART DETAY AKSESUAR

11 030123-DORMA TS 91 SOFTLINE KAP.POM.N

11 030122-DORMA TS 90 SOFTLINE KAP.POM.N

11 030103-DORMA TS 71 KAYAR KOL KAP. POM

11 030104-DORMA TS 72 NR.KL.KAPI POMPASI

11 030115-DORMA TS 89 KAPI POMPASI

11 030124-DORMA TS 92 SOFTLINE KAP.POM.N

11 030125-DORMA TS 93 SOFTLINE KAP.POM.N

11 030205-DORMA BTS 65 GÖM. KAPI POMPASI

11 030210-DORMA BTS 84 GÖM KAPI POMPASI



GEZE TS 1000 POMPA (DİRSEKLİ)

GEZE TS 1500 POMPA (KAYAR KOLLU - DİRSEKLİ)

GEZE TS 2000 POMPA (KAYAR KOLLU - DİRSEKLİ)

GEZE TS 3000 POMPA (KAYAR KOLLU)

GEZE TS 4000 POMPA (KAYAR KOLLU)

GEZE TS 5000 POMPA (KAYAR KOLLU)



11 031021

VARIA GIESSE YÜKSEK AÇILIM





STOK KODU

STOK CİNSİ



11 021309	SDS-PLUS MATKAP UCU 6*160 MM
11 021310	SDS-PLUS MATKAP UCU 6*210 MM
11 021313	SDS-PLUS MATKAP UCU 7*160 MM
11 021314	SDS-PLUS MATKAP UCU 7*210 MM
11 021315	SDS-PLUS MATKAP UCU 8*110 MM
11 021316	SDS-PLUS MATKAP UCU 8*160 MM
11 021317	SDS-PLUS MATKAP UCU 8*210 MM
11 021324	SDS-PLUS MATKAP UCU 10*160 MM
11 021325	SDS-PLUS MATKAP UCU 10*210 MM
11 021334	SDS PLUS MATKAP UCU 12*210 MM
11 021342	SDS PLUS MATKAP UCU 14,210 MM
11 021361	SDS PLUS MATKAP UCU 18*200 MM
11 021371	SDS PLUS MATKAO UCU 20*300 MM
11 021400	SDS MATKAP UCU 6*210 MM
11 021401	SDS MATKAP UCU 7*210 MM
11 021402	SDS MATKAP UCU 8*210 MM
11 021403	SDS MATKAP UCU 10*210 MM
11 021404	SDS MATKAP UCU 12*210 MM
11 021405	SDS MATKAP UCU 14*200 MM
11 021406	SDS MATKAP UCU 16*200 MM
11 021407	SDS MATKAP UCU 18*200 MM
11 021408	SDS MATKAP UCU 20*200 MM
11 021410	SDS MATKAP UCU 6*260 MM
11 021412	SDS MATKAP UCU 7*260 MM





02 070106  
PİLANA ELMAS TESTERE  
250X3.2X80

02 070104  
PİLANA ELMAS TESTERE  
300X3.2X96

02 070105  
PİLANA ELMAS TESTERE  
400X3.6X120

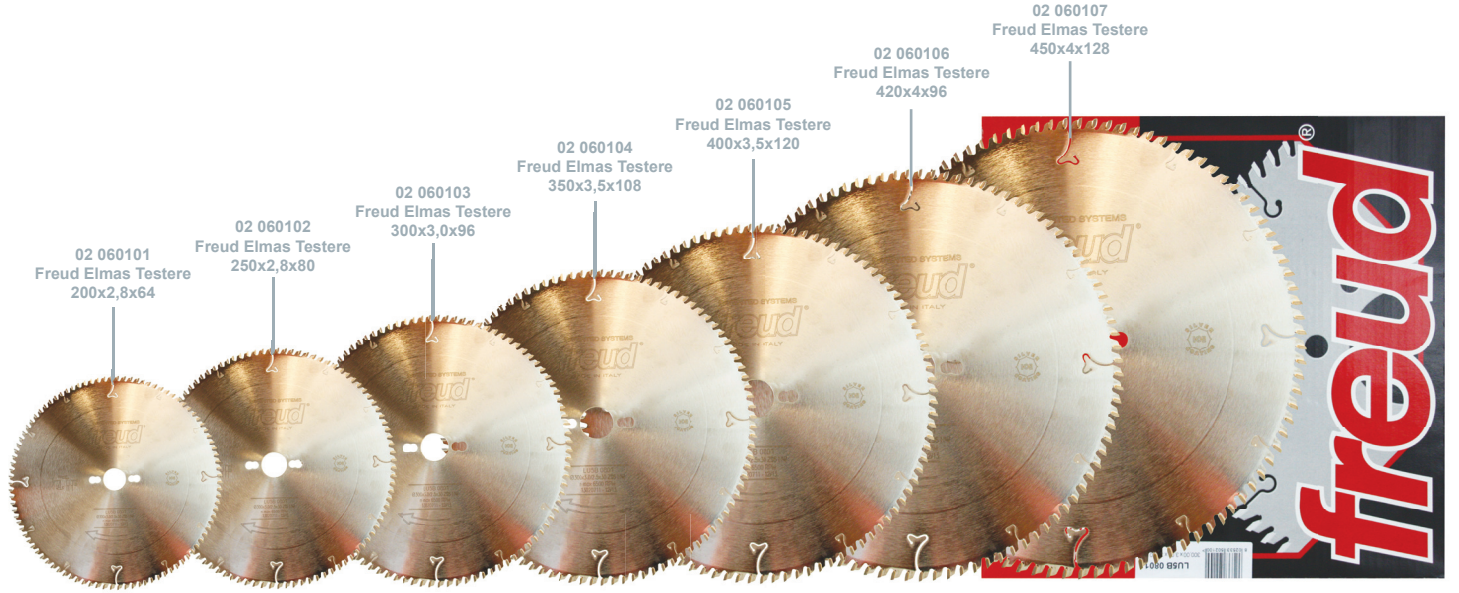

02 060101  
Freud Elmas Testere  
200x2,8x64

02 060102  
Freud Elmas Testere  
250x2,8x80

02 060103  
Freud Elmas Testere  
300x3,0x96

02 060104  
Freud Elmas Testere  
350x3,5x108

02 060105  
Freud Elmas Testere  
400x3,5x120

02 060106  
Freud Elmas Testere  
420x4x96

02 060107  
Freud Elmas Testere  
450x4x128



- 11 021000-3.0 MM HSS MATKAP UCU
- 11 021002-4.0 MM HSS MATKAP UCU
- 11 021005-4.5 MM HSS MATKAP UCU
- 11 021006-5.0 MM HSS MATKAP UCU
- 11 021007-5.5 MM HSS MATKAP UCU
- 11 021008-6.0 MM HSS MATKAP UCU
- 11 021009-7.0 MM HSS MATKAP UCU
- 11 021010-8.0 MM HSS MATKAP UCU



02 070200-ALUCOBONT DAİRE BİÇAĞI

02 010900

ALM. KERTME BİÇAĞI  
(ÜÇLÜ)



11 020100  
ELMAS UÇ  
ÇAPAK ALMA



11 020400  
ALUCOBOND  
HAVSA  
FREZE UCU



11 020300  
5\*13/60\*8 MM  
FREZE UCU



11 020320  
5\*16/80\*8 MM  
FREZE UCU



11 020330  
5\*25/55\*100 MM  
FREZE UCU

20 110154

MAKİTA MATKAP HP 1641



20 110156

MAKİTA MATKAP 6413



11 040305

HR 2470 MAKİTA KIRICI DELİCİ



11 040410

MAKİTA 4530  
AVUÇ TAŞLAMA



11 040500

GA 7020 180MM  
TAŞLAMA MAKİTA

11 040505

GA 9020 230MM  
TAŞLAMA MAKİTA



11 040725

MAKİTA 6271 DWPLE  
AKÜLÜ MATKAP



11 042000

DİK FREZE MRP 900



20 050334

MAKİTA SUNTA  
KESME 5900 B



11 041010

MAKİTA DEKUBAJ 4327



20 110155

MAKİTA MATKAP 1631



11 040728

MAKİTA SUNTA KESME  
SP 6000 K AÇILI

11 040729

MAKİTA 194368-5  
KLAUVUZ AYI 1,4 MT



11 080400

OPT 232 10 MM  
MATKAP OSAKA



11 080420

OPT 4080-6  
TORNAVIDA  
OSAKA



11 080430

OPT 127  
TAŞLAMA OSAKA



11 080105

OPT 3042 FRL  
OSAKA  
ŞARTLANDIRICI 1/2"



11 080115-LÜDECKE  
DWS38ES İKİLİ  
STOPER

11 080120-LÜDECKE  
VWS38 3'LÜ GÖVDE

11 080125-LÜDECKE  
ES14NA 1/4 ERKEK



08 080103

MAG LİTRE YAĞ



11 080100

HAVA  
TABANCASI KISA



11 140100

180\*3 MERMER  
KESİCİ DİSK  
KARBOSAN



11 080110

LÜDECKE ES14I  
DİŞİ GÖVDE



11 080103

OPT05-50  
5\*8MM\*15MT  
HORTUM



11 020501

GRANİT MERMER  
PANÇ



11 140102

300\*3 METAL  
KESİCİ DİSK  
KARBOSAN



11 042003

ERSİM ÇANTA  
KAYNAK MAK.  
250 A KLASİK



11 120201

PU 01 KÖPÜK  
TABANCASI



11 220104

TOMAX  
ISKARPELA 20



11 120103

SİLİKON  
TABANCASI



11 150102

GRS015 3X1.5MM  
50MT MONO  
SARAÇ



11 200200

UFAK İŞKENCE



11 130202

DEMİR TESTERE  
KOLU RONEY 411



MIKNATISLI SU  
TERAZİSİ 60 CM,  
80 CM, 100 CM,  
120 CM



11 060201

FİSCO METRE  
UM 5



11 060200

FİSCO METRE  
UM 3



HON SU  
TERAZİSİ 60 CM,  
80 CM, 100 CM,  
120 CM



11 170208

GAZLI CAM  
ELMASI  
SILBERSCHNITT



11 170100

SILBERSCHNITT  
CAM KESME  
ELMASI



11 170200

GAZLI CAM  
ELMASI METAL



11 130101

MAKET BİÇAĞI  
PRO - KRAFT



11 160202

M-02-ÜÇLÜ  
VANTUZ PLS



11 160201

M-0212-İKİLİ  
VANTUZ PLS



11 130204

FİTİL KESME  
MAKASI JBM



04 070102

CONTA ÇEKME  
MAKARASI

04 022028

SİNEKLİK FİTİL  
TAKMA APARATI

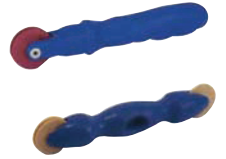

11 210101

PERÇİN  
TABANCASI



11 210102

PERÇİN  
TABANCASI  
İZELTAŞ



08 070102

HIZLI  
YAPIŞTIRICI  
JAPON 20 GR



11 100106

8"YARIM  
YUVARLAK EĞE



11 100100

6" LAMA  
EĞE KALIN



ALLEN ANAHTAR  
2,5 MM - 3 MM  
4 MM - 5 MM - 6 MM



11 240102  
KARGABURUN  
160 MM

11 240101  
YAN KESKİ  
160 MM

11 240100  
KOMBİNE PENSE  
8\*180 MM



11 240104  
RONEY İŞ  
ELDİVENİ GRİ

11 240103  
RONEY İŞ  
ELDİVENİ KIRMIZI



11 230101

21 LİK PLASTİK  
TAKIM ÇANTASI





11 110210

ALLEN ANAHTAR  
TAKIMI



T ALLEN ANAHTAR

2,5 MM - 3 MM - 4 MM  
5 MM - 6 MM



DÜZ UÇLU TORNAVİDA

5\*100 - 5\*150 - 6\*125  
6\*150 - 8\*150 - 8\*175



YILDIZ TORNAVİDA

4\*125 - 5\*100 - 5\*125  
6\*125 - 6\*150 - 7\*150  
8\*150



11 190102

10-3/8 MANDREN  
ELLE SIKMALI



11 220102

PC 700 KISA MİLLİ  
YÜZ.TEM.AL.



02 020202

PY 100-KÖŞE  
PATLATMA PRESİ  
(ALDOKS)



02 020205

PY 104-KÖŞE  
PATLATMA PRESİ  
(SİGMA)



02 020203

PY 101-KÖŞE  
PATLATMA PRESİ  
(YUNAN)



02 020204

PY 102-KÖŞE  
PATLATMA PRESİ  
(ÇİFT ZİMBALİ)



02 100118

DKÇ 500 D  
KOMPRÖSÖR



02 100150  
FK 1600 HAVA  
KURUTUCU 1600

02 100210  
FF 1600 FİLTRE  
EL TAHLİYELİ



02 010101

ALFA- 300 LÜK  
PORTATİF PROFİL  
KESİM



02 010103

BETA-300 LÜK  
YATARLI PORTATİF  
KESİM



02 010501

POLAR-I-PORTATİF  
ORTA KAYIT  
ALIŞTIRMA



02 010201

STAR-PORTATİF  
KOPYA FREZE  
MAKİNESİ



02 010116

ALFAMİNİ 250 LİK  
PORT. PROF.  
KESİM



02 010108

METEOR I-OTOMATİK  
ALTTAN ÇIKMA  
KESİM



02 010115

ORCA- ÇİTA  
KESME  
MAKİNESİ



02 010303

ORION I -TEK  
KÖŞE PVC  
KAYNAK MAKİNASI



02 010302

APEX-OTO.  
HİDROLİK ALM.  
KÖŞE PRESİ - 400 V



02 010203

GALAXY II-3 'LÜ KOL  
YERİ DELMELİ  
KOPYA FREZE



02 010502

POLAR II-MANUEL  
ORTA KAYIT  
ALIŞTIRMA MAKİNASI



02 010401

ORBIT I-OTO.  
PVC TEK KÖŞE  
TEMİZLEME MAKİNESİ  
4 BIÇAKLI-400 V



02 020201

KP 120 ALM. KÖŞE  
BİRLEŞTİRME PRESİ  
(HİDROLİK) 400 V



02 020206

TK 501-PVC TEK KÖŞE  
KAYNAK MAKİNESİ  
230 V



02 020105

KD 350 P-DER. KES.  
MAKİNESİ (350 MM  
TESTERELİ, SEHPALI,  
PNO.) 400 V



02 020503

KM 212-ORTA KAYIT  
AL. MAKİNESİ  
(PORTATİF) 230 V-400 V



02 020112

ÇK 411 -PVC ÇITA  
KESME MAKİNESİ  
(OTO.ÖLÇÜ ALMA  
APRT)400 V



02 020304

FR 222-KOPYA FREZE  
MAKİNESİ  
(PORTATİF) 230 V



02 020506

KM-215- ORTA  
KAYIT ALIŞTIRMA  
MAKİNESİ



02 020110

AÇK 420-ALTAN  
ÇIKMA KESME  
MAKİNESİ



02 020306

FR 225-K. FREZE  
MAKİNESİ 400 V



02 020102

KY 300-YATARLI DER.  
KES. MAKİNESİ  
(230 V- 400 V)



02 040201

OTOMATİK KÖŞE  
TEMİZLEME MAKİNASI



02 040302

OTOMATİK ÇİTA  
KESME MAKİNASI



02 040401

OTOMATİK ORTA KAYIT  
ALIŞTIRMA-KERTME  
MAKİNASI



02 040101

TEK KÖŞE KAYNAK  
MAKİNASI



02 040301

OTOMATİK ALTTAN  
ÇIKMA KESİM  
MAKİNASI



02 040501

KOPYA FREZELEME  
ÜÇLÜ KOL YERİ DELME  
SU TAHLİYE MAKİNASI



**AKPA**<sup>®</sup>  
ALÜMİNYUM SANAYİ VE TİCARET A.Ş.

[www.akpaas.com.tr](http://www.akpaas.com.tr)

